

# More Proofs of Divergence of the Harmonic Series

Steven J. Kifowit  
Prairie State College

In an earlier article, Kifowit and Stamps [15] summarized a number of elementary proofs of divergence of the harmonic series:

$$\sum_{n=1}^{\infty} \frac{1}{n} = 1 + \frac{1}{2} + \frac{1}{3} + \frac{1}{4} + \frac{1}{5} + \cdots = \infty.$$

For a variety of reasons, some very nice proofs never made it into the final draft of that article. With this in mind, the collection of divergence proofs continues here. This informal note is a work in progress<sup>1</sup>. On occasion more proofs will be added. Accessibility to first-year calculus students is a common thread that will continue (usually) to connect the proofs.

## Proof 21 (A geometric series proof)

Choose a positive integer  $k$ .

$$\begin{aligned} \sum_{n=1}^{\infty} \frac{1}{n} &= 1 + \overbrace{\left( \frac{1}{2} + \frac{1}{3} + \cdots + \frac{1}{k+1} \right)}^{k \text{ terms}} + \overbrace{\left( \frac{1}{k+2} + \frac{1}{k+3} + \cdots + \frac{1}{k^2+k+1} \right)}^{k^2 \text{ terms}} \\ &\quad + \overbrace{\left( \frac{1}{k^2+k+2} + \frac{1}{k^2+k+3} + \cdots + \frac{1}{k^3+k^2+k+1} \right)}^{k^3 \text{ terms}} + \cdots \\ &> 1 + \frac{k}{k+1} + \frac{k^2}{k^2+k+1} + \frac{k^3}{k^3+k^2+k+1} + \cdots \\ &> 1 + \left( \frac{k}{k+1} \right) + \left( \frac{k}{k+1} \right)^2 + \left( \frac{k}{k+1} \right)^3 + \cdots \\ &= \frac{1}{1 - \frac{k}{k+1}} = k + 1 \end{aligned}$$

Since this is true for any positive integer  $k$ , the harmonic series must diverge.

---

<sup>1</sup>First posted January 2006. Last updated June 23, 2019.

## Proof 22

The following proof was given by Fearnough [11] and later by Havil [12]. After substituting  $u = e^x$ , this proof is equivalent to Proof 10 of [15].

$$\begin{aligned}\int_{-\infty}^0 \frac{e^x}{1 - e^x} dx &= \int_{-\infty}^0 e^x(1 - e^x)^{-1} dx \\ &= \int_{-\infty}^0 e^x(1 + e^x + e^{2x} + e^{3x} + \dots) dx \\ &= \int_{-\infty}^0 (e^x + e^{2x} + e^{3x} + \dots) dx \\ &= \left[ e^x + \frac{1}{2}e^{2x} + \frac{1}{3}e^{3x} + \dots \right]_{-\infty}^0 \\ &= 1 + \frac{1}{2} + \frac{1}{3} + \dots \\ &= [-\ln(1 - e^x)]_{-\infty}^0 = \infty\end{aligned}$$

## Proof 23 (A telescoping series proof)

This proof was given by Bradley [4] and later by Baker [2]. We begin with the inequality  $x \geq \ln(1 + x)$ , which holds for all  $x > -1$ . From this it follows that

$$\frac{1}{k} \geq \ln\left(1 + \frac{1}{k}\right) = \ln(k + 1) - \ln(k)$$

for any positive integer  $k$ . Now we have

$$\begin{aligned}H_n &= \sum_{k=1}^n \frac{1}{k} \\ &\geq \sum_{k=1}^n \ln\left(1 + \frac{1}{k}\right) = \sum_{k=1}^n \ln\left(\frac{k+1}{k}\right) \\ &= [\ln(n+1) - \ln(n)] + [\ln(n) - \ln(n-1)] + \dots + [(\ln(2) - \ln(1))] \\ &= \ln(n+1).\end{aligned}$$

Therefore  $\{H_n\}$  is unbounded, and the harmonic series diverges.

## Proof 24 (A limit comparison proof)

In the last proof the harmonic series was directly compared to the divergent series  $\sum_{k=1}^{\infty} \ln\left(1 + \frac{1}{k}\right)$ . The use of the inequality  $x \geq \ln(1 + x)$  can be avoided by using limit comparison. Since

$$\lim_{x \rightarrow \infty} \frac{\ln\left(1 + \frac{1}{x}\right)}{\frac{1}{x}} = \lim_{x \rightarrow \infty} \frac{-\frac{1}{x^2}}{\left(1 + \frac{1}{x}\right)\left(-\frac{1}{x^2}\right)} = 1,$$

the harmonic series diverges by limit comparison.

## Proof 25

In an interesting proof of the Egyptian fraction theorem, Owings [22] showed that no number appears more than once in any single row of the following tree.

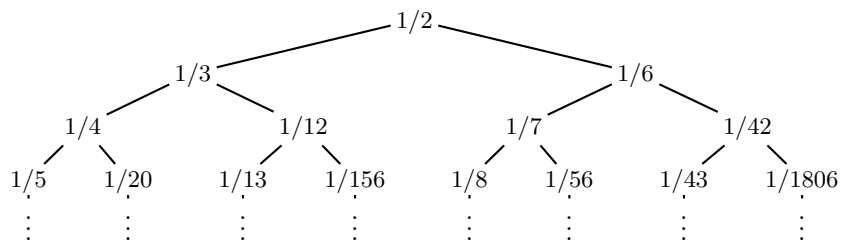

The elements of each row have a sum of  $1/2$ , and there are infinitely rows with no elements in common. (For example, one could, starting with row 1, find the maximum denominator in the row, and then jump to that row.) It follows that the harmonic series diverges.

## Proof 26

This proof is actually a pair of very similar proofs. They are closely related to a number of other proofs, but most notably to Proof 4 of [15]. In these proofs  $H_n$  denotes the  $n$ th partial sum of the harmonic series:

$$H_n = 1 + \frac{1}{2} + \frac{1}{3} + \cdots + \frac{1}{n}, \quad n = 1, 2, 3, \dots$$

Proof (A): First notice that

$$H_n + H_{2n} = 2H_n + \frac{1}{n+1} + \frac{1}{n+2} + \cdots + \frac{1}{2n} \geq 2H_n + \frac{n}{2n},$$

so that when all is said and done, we have

$$H_n + H_{2n} \geq 2H_n + \frac{1}{2}.$$

Now suppose the harmonic series converges with sum  $S$ .

$$\begin{aligned} 2S &= \lim_{n \rightarrow \infty} H_n + \lim_{n \rightarrow \infty} H_{2n} \\ &= \lim_{n \rightarrow \infty} (H_n + H_{2n}) \\ &\geq \lim_{n \rightarrow \infty} \left( 2H_n + \frac{1}{2} \right) \\ &= 2S + \frac{1}{2} \end{aligned}$$

The contradiction  $2S \geq 2S + \frac{1}{2}$  concludes the proof.

Proof (B): This proof was given by Ward [28].

$$H_{2n} - H_n = \frac{1}{n+1} + \frac{1}{n+2} + \cdots + \frac{1}{2n} \geq \frac{n}{2n} = \frac{1}{2}$$

Suppose the harmonic series converges.

$$\begin{aligned}
 0 &= \lim_{n \rightarrow \infty} H_{2n} - \lim_{n \rightarrow \infty} H_n \\
 &= \lim_{n \rightarrow \infty} (H_{2n} - H_n) \\
 &\geq \lim_{n \rightarrow \infty} \frac{1}{2} = \frac{1}{2}
 \end{aligned}$$

The contradiction  $0 \geq \frac{1}{2}$  concludes the proof.

## Proof 27

This proposition follows immediately from the harmonic mean/arithmetic mean inequality, but an alternate proof is given here.

*Proposition:* For any natural number  $k$ ,  $\frac{1}{k} + \frac{1}{k+1} + \cdots + \frac{1}{3k} > 1$ .

Proof:

$$\begin{aligned}
 \exp\left(\frac{1}{k} + \frac{1}{k+1} + \frac{1}{k+2} + \cdots + \frac{1}{3k}\right) &= e^{1/k} \cdot e^{1/(k+1)} \cdot e^{1/(k+2)} \cdots e^{1/(3k)} \\
 &> \left(1 + \frac{1}{k}\right) \cdot \left(1 + \frac{1}{k+1}\right) \cdot \left(1 + \frac{1}{k+2}\right) \cdots \left(1 + \frac{1}{3k}\right) \\
 &= \left(\frac{k+1}{k}\right) \cdot \left(\frac{k+2}{k+1}\right) \cdot \left(\frac{k+3}{k+2}\right) \cdots \left(\frac{3k+1}{3k}\right) \\
 &= \frac{3k+1}{k} > 3.
 \end{aligned}$$

(In this proposition the denominator  $3k$  could be replaced by  $\lfloor ek \rfloor$ , but even this choice is not optimal. See [3] and [6].)

Based on this proposition, we have the following result:

$$\begin{aligned}
 \sum_{n=1}^{\infty} \frac{1}{n} &= 1 + \left(\frac{1}{2} + \cdots + \frac{1}{6}\right) + \left(\frac{1}{7} + \cdots + \frac{1}{21}\right) + \left(\frac{1}{22} + \cdots + \frac{1}{66}\right) + \cdots \\
 &> 1 + 1 + 1 + 1 + \cdots
 \end{aligned}$$

## Proof 28 (A Fibonacci number proof)

The following proof was given by Kifowit and Stamps [14] and by Chen and Kennedy [5].

The Fibonacci numbers are defined recursively as follows:

$$f_0 = 1, \quad f_1 = 1; \quad f_{n+1} = f_n + f_{n-1}, \quad n = 1, 2, 3, \dots$$

For example, the first ten are given by 1, 1, 2, 3, 5, 8, 13, 21, 34, 55. The sequence of Fibonacci numbers makes an appearance in a number of modern calculus textbooks (for instance, see [18] or [27]). Often the limit

$$\lim_{n \rightarrow \infty} \frac{f_{n+1}}{f_n} = \phi = \frac{1 + \sqrt{5}}{2}$$

is proved or presented as an exercise. This limit plays an important role in this divergence proof.

First notice that

$$\lim_{n \rightarrow \infty} \frac{f_{n-1}}{f_{n+1}} = \lim_{n \rightarrow \infty} \frac{f_{n+1} - f_n}{f_{n+1}} = \lim_{n \rightarrow \infty} \left( 1 - \frac{f_n}{f_{n+1}} \right) = 1 - \frac{1}{\phi} \approx 0.381966.$$

Now we have

$$\begin{aligned} \sum_{n=1}^{\infty} \frac{1}{n} &= 1 + \frac{1}{2} + \frac{1}{3} + \frac{1}{4} + \frac{1}{5} + \frac{1}{6} + \dots \\ &= 1 + \frac{1}{2} + \frac{1}{3} + \left( \frac{1}{4} + \frac{1}{5} \right) + \left( \frac{1}{6} + \frac{1}{7} + \frac{1}{8} \right) \\ &\quad + \left( \frac{1}{9} + \dots + \frac{1}{13} \right) + \left( \frac{1}{14} + \dots + \frac{1}{21} \right) + \dots \\ &\geq 1 + \frac{1}{2} + \frac{1}{3} + \frac{2}{5} + \frac{3}{8} + \frac{5}{13} + \frac{8}{21} + \dots \\ &= 1 + \sum_{n=1}^{\infty} \frac{f_{n-1}}{f_{n+1}} \end{aligned}$$

Since  $\lim_{n \rightarrow \infty} \frac{f_{n-1}}{f_{n+1}} \neq 0$ , this last series diverges. It follows that the harmonic series diverges.

## Proof 29

This proof is essentially the same as Proof 2 of [15]. First notice that since the sequence

$$\frac{11}{10}, \frac{111}{100}, \frac{1111}{1000}, \frac{11111}{10000}, \dots$$

increases and converges to  $10/9$ , the sequence

$$\frac{10}{11}, \frac{100}{111}, \frac{1000}{1111}, \frac{10000}{11111}, \dots$$

decreases and converges to  $9/10$ . With this in mind, we have

$$\begin{aligned} \sum_{n=1}^{\infty} \frac{1}{n} &= 1 + \overbrace{\left( \frac{1}{2} + \frac{1}{3} + \dots + \frac{1}{11} \right)}^{10 \text{ terms}} + \overbrace{\left( \frac{1}{12} + \frac{1}{13} + \dots + \frac{1}{111} \right)}^{100 \text{ terms}} \\ &\quad + \overbrace{\left( \frac{1}{112} + \frac{1}{113} + \dots + \frac{1}{1111} \right)}^{1000 \text{ terms}} + \dots \\ &> 1 + \frac{10}{11} + \frac{100}{1111} + \frac{1000}{11111} + \dots \\ &> 1 + \frac{9}{10} + \frac{9}{10} + \frac{9}{10} + \dots \end{aligned}$$

## Proof 30

The following visual proofs show that by carefully rearranging terms, the harmonic series can be made greater than itself.

Proof (A): This proof without words was posted on *The Everything Seminar* (Harmonic Digression, <http://cornellmath.wordpress.com/2007/07/12/harmonic-digression/>).

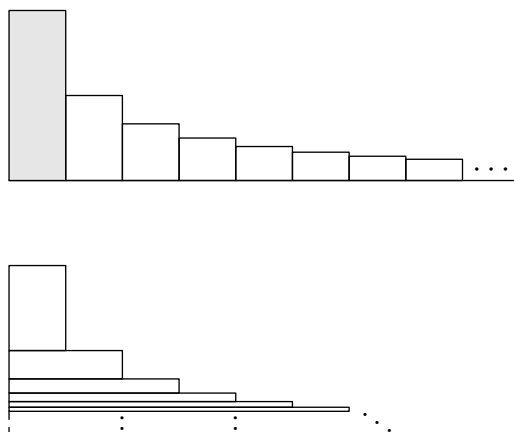

Figure 1: Proof 30(A)

Proof (B): This visual proof leaves less to the imagination than Proof (A). It is due to Jim Belk and was posted on *The Everything Seminar* as a follow-up to the previous proof. Belk's proof is a visualization of Johann Bernoulli's proof (see Proof 13 of [15]).

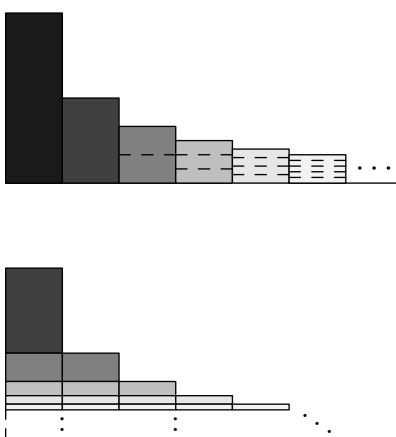

Figure 2: Proof 30(B)

Proof (C): This proof is a visual representation of Proofs 6 and 7 of [15]. With some minor modifications,

a similar visual proof could be used to show that one-half of the harmonic series ( $\frac{1}{2} + \frac{1}{4} + \frac{1}{6} + \dots$ ) is strictly less than its remaining half (in the spirit of Proof 8 of [15]).

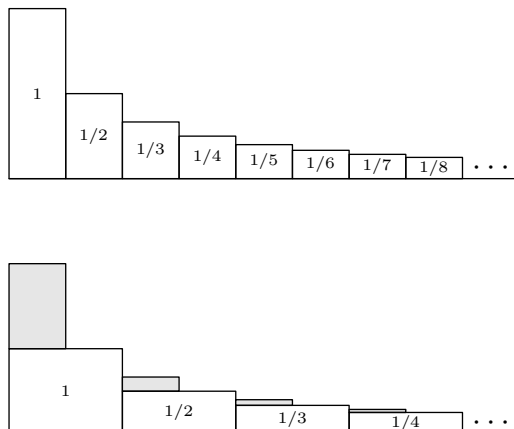
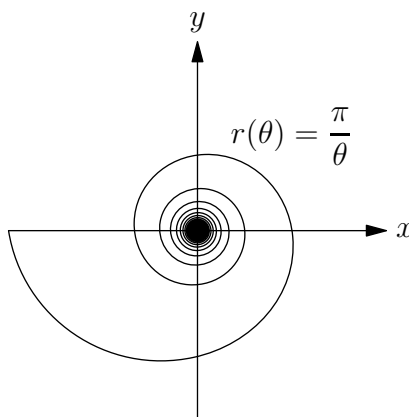

Figure 3: Proof 30(C)

## Proof 31

Here is another proof in which  $\sum 1/k$  and  $\int 1/x dx$  are compared. Unlike its related proofs (e.g. Proof 9 of [15]), this one focuses on arc length.

The graph shown here is that of the polar function  $r(\theta) = \pi/\theta$  on  $[\pi, \infty)$ .



The total arc length is unbounded:

$$\text{Arc Length} = \int_{\pi}^{\infty} \sqrt{r^2 + \left(\frac{dr}{d\theta}\right)^2} d\theta \geq \int_{\pi}^{\infty} \sqrt{r^2} d\theta = \int_{\pi}^{\infty} r d\theta = \int_{\pi}^{\infty} \frac{\pi}{\theta} d\theta = \pi \ln \theta \Big|_{\pi}^{\infty} = \infty$$

Now let the polar function  $\rho$  be defined by

$$\rho(\theta) = \begin{cases} 1, & \pi \leq \theta < 2\pi \\ 1/2, & 2\pi \leq \theta < 3\pi \\ 1/3, & 3\pi \leq \theta < 4\pi \\ \vdots & \vdots \\ 1/n, & n\pi \leq \theta < (n+1)\pi \\ \vdots & \vdots \end{cases}$$

The graph of  $\rho$  is made up of semi-circular arcs, the  $n$ th arc having radius  $1/n$ . The total arc length of the graph of  $\rho$  is

$$\pi + \frac{\pi}{2} + \frac{\pi}{3} + \frac{\pi}{4} + \cdots = \pi \left( 1 + \frac{1}{2} + \frac{1}{3} + \frac{1}{4} + \cdots \right).$$

The graphs of  $r$  (dashed) and  $\rho$  (solid) on  $[\pi, 6\pi]$  are shown below.

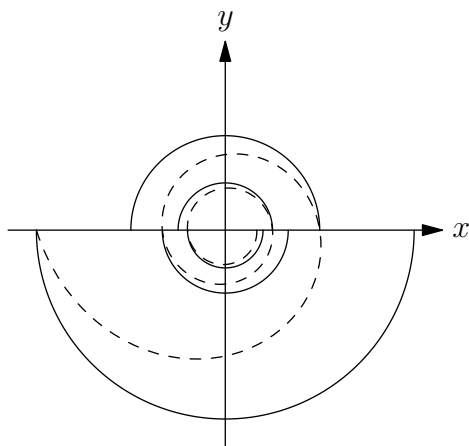

By comparing the graphs of the two functions over intervals of the form  $[n\pi, (n+1)\pi]$ , we see that the graph of  $\rho$  must be “longer” than the graph of  $r$ . It follows that

$$\pi \left( 1 + \frac{1}{2} + \frac{1}{3} + \frac{1}{4} + \cdots \right)$$

must be unbounded.

## Proof 32

The divergence of the harmonic series follows immediately from the Cauchy Condensation Test:

*Suppose  $\{a_n\}$  is a non-increasing sequence with positive terms. Then  $\sum_{n=1}^{\infty} a_n$  converges if and*

*only if  $\sum_{k=0}^{\infty} 2^k a_{2^k}$  converges.*



## Proof 33

This proof is similar to Proof 4 of [15]. Just as above,  $H_n$  denotes the  $n$ th partial sum of the harmonic series:

$$H_n = 1 + \frac{1}{2} + \frac{1}{3} + \cdots + \frac{1}{n}, \quad n = 1, 2, 3, \dots$$

Consider the figure shown here:

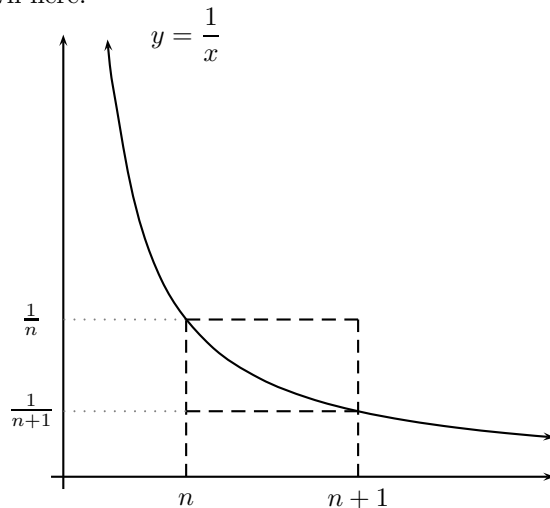

Referring to the figure, we see that

$$\frac{1}{n+1} < \int_n^{n+1} \frac{1}{x} dx < \frac{1}{n}.$$

Repeated use of this result gives

$$\underbrace{\frac{1}{n+1} + \cdots + \frac{1}{2n}}_{H_{2n} - H_n} < \int_n^{2n} \frac{1}{x} dx = \ln 2 < \underbrace{\frac{1}{n} + \cdots + \frac{1}{2n-1}}_{H_{2n-1} - H_{n-1}}$$

or

$$H_{2n} - H_n < \ln 2 < H_{2n} - H_n + \underbrace{\frac{1}{n} - \frac{1}{2n}}_{1/2n}.$$

From this it follows that

$$\ln 2 - \frac{1}{2n} < H_{2n} - H_n < \ln 2.$$

Therefore  $H_{2n} - H_n \rightarrow \ln 2$ , and the sequence  $\{H_n\}$  must diverge.

## Proof 34

In [10] Paul Erdős gave two remarkably clever proofs of the divergence of the series  $\sum 1/p$  ( $p$  prime), where the sum is taken over only the primes. Other proofs of this fact, such as one given by Euler (see [9]), make use of the harmonic series. Erdős' proofs do not, and as a consequence, they establish the divergence of the harmonic series.

The proofs are rather complicated, but accessible and well worth the effort required to follow them through. A few elementary ideas are required before we begin:

- (i)  $\lfloor x \rfloor$  denotes the greatest integer less than or equal to  $x$ .
- (ii) We denote the primes, in ascending order, by  $p_1, p_2, p_3, p_4, \dots$
- (iii) Let  $N$  be a given positive integer. For any positive integer  $m$ , there are  $\lfloor N/m \rfloor$  integers between 1 and  $N$  that are divisible by  $m$ .

This is the first of Erdős' proofs. We begin by assuming  $\sum_{i=1}^{\infty} \frac{1}{p_i}$  converges. It follows that there exists an integer  $K$  such that

$$\sum_{i=K+1}^{\infty} \frac{1}{p_i} < \frac{1}{2}.$$

We will call  $p_{K+1}, p_{K+2}, p_{K+3}, \dots$  the "large primes," and  $p_1, p_2, \dots, p_K$  the "small primes."

Now let  $N$  be an integer such that  $N > p_K$ . Let  $N_1$  be the number of integers between 1 and  $N$  whose divisors are all small primes, and let  $N_2$  be the number of integers between 1 and  $N$  that have at least one large prime divisor. It follows that  $N = N_1 + N_2$ .

By the definition of  $N_2$  and using (iii) above, it follows that

$$N_2 \leq \left\lfloor \frac{N}{p_{K+1}} \right\rfloor + \left\lfloor \frac{N}{p_{K+2}} \right\rfloor + \left\lfloor \frac{N}{p_{K+3}} \right\rfloor + \dots = \sum_{i=K+1}^{\infty} \left\lfloor \frac{N}{p_i} \right\rfloor.$$

From this we get

$$N_2 \leq \sum_{i=K+1}^{\infty} \left\lfloor \frac{N}{p_i} \right\rfloor \leq \sum_{i=K+1}^{\infty} \frac{N}{p_i} < \frac{N}{2},$$

where the last part of the inequality follows from the definition of  $K$ .

Now, referring back to the small primes, let  $x \leq N$  be a positive integer with only small prime divisors. Write  $x = yz^2$ , where  $y$  and  $z$  are positive integers,  $y$  is squarefree (i.e. has no perfect square divisors), and  $z \leq \sqrt{N}$ . The integer  $y$  must have the factorization

$$y = p_1^{m_1} p_2^{m_2} p_3^{m_3} \dots p_K^{m_K},$$

where each exponent  $m_i$  has value 0 or 1. It follows from the multiplication principle that there are  $2^K$  possible choices for the integer  $y$ . Since  $z \leq \sqrt{N}$ , there are at most  $\sqrt{N}$  possible choices for the integer  $z$ . Therefore there are at most  $2^K \sqrt{N}$  possible choices for the integer  $x$ . Recalling the definition of  $x$ , we see that we must have  $N_1 \leq 2^K \sqrt{N}$ .

So now we have established that

$$N = N_1 + N_2 < 2^K \sqrt{N} + \frac{N}{2}.$$

However, by simply choosing  $N$  such that  $N > 2^{2K+2}$ , we are lead to a contradiction:

$$N = N_1 + N_2 < 2^K \sqrt{N} + \frac{N}{2} < \frac{\sqrt{N}}{2} \sqrt{N} + \frac{N}{2} = N.$$

## Proof 35

This is Erdős' second proof of the divergence of  $\sum 1/p$  ( $p$  prime) [10]. It uses the same notation and concepts as the previous proof.

We begin by using the fact that

$$\sum_{i=2}^{\infty} \frac{1}{i(i+1)} = \sum_{i=2}^{\infty} \left( \frac{1}{i} - \frac{1}{i+1} \right) = \frac{1}{2}$$

to establish that

$$\sum_{i=1}^{\infty} \frac{1}{p_i^2} < \frac{1}{4} + \frac{1}{2 \cdot 3} + \frac{1}{3 \cdot 4} + \frac{1}{4 \cdot 5} + \cdots = \frac{1}{4} + \frac{1}{2} = \frac{3}{4}.$$

Now assume that  $\sum_{i=1}^{\infty} \frac{1}{p_i}$  converges. It follows that there exists an integer  $K$  such that

$$\sum_{i=K+1}^{\infty} \frac{1}{p_i} < \frac{1}{8}.$$

As above, we will call  $p_{K+1}, p_{K+2}, p_{K+3}, \dots$  the "large primes," and  $p_1, p_2, \dots, p_K$  the "small primes."

Let  $N$  be a positive integer and let  $y \leq N$  be a positive, squarefree integer with only small prime divisors. The integer  $y$  must have the factorization

$$y = p_1^{m_1} p_2^{m_2} p_3^{m_3} \cdots p_K^{m_K},$$

where each exponent  $m_i$  has value 0 or 1. It follows from the multiplication principle that there are  $2^K$  possible choices for the integer  $y$ . Those  $2^k$  integers must remain after we remove from the sequence  $1, 2, 3, \dots, N$  all those integers that are not squarefree or have large prime divisors. Therefore, we must have the following inequality:

$$2^K \geq N - \sum_{i=1}^K \left\lfloor \frac{N}{p_i^2} \right\rfloor - \sum_{i=K+1}^{\infty} \left\lfloor \frac{N}{p_i} \right\rfloor \geq N - \sum_{i=1}^K \frac{N}{p_i^2} - \sum_{i=K+1}^{\infty} \frac{N}{p_i} > N - \frac{3}{4}N - \frac{1}{8}N = \frac{N}{8}.$$

However, if we simply choose  $N \geq 2^{K+3}$ , we have a contradiction.

## Proof 36

Nick Lord [19] provided this “visual catalyst” for Proof 23.

Consider the graph of  $y = \sin(e^x)$  for  $0 \leq x < \infty$ .

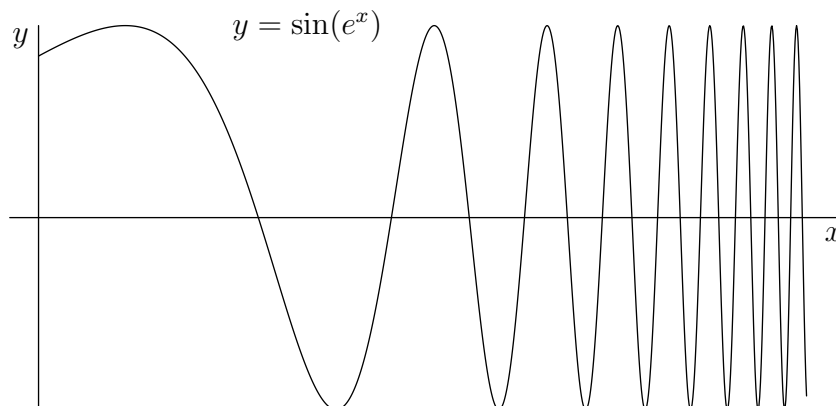

The graph has an  $x$ -intercept at the point where  $x = \ln n\pi$  for each positive integer  $n$ . This sequence of  $x$ -values diverges to infinity, and the distance between each pair of intercepts is given by

$$\ln(n+1)\pi - \ln n\pi = \ln\left(\frac{n+1}{n}\right) = \ln\left(1 + \frac{1}{n}\right).$$

Since  $\ln(1 + \frac{1}{n}) < \frac{1}{n}$  for each  $n$ , the series of gaps between intercepts has a total length less than the harmonic series:

$$\sum_{n=1}^{\infty} \ln\left(1 + \frac{1}{n}\right) < \sum_{n=1}^{\infty} \frac{1}{n}.$$

Since the sequence of  $x$ -intercepts diverges, the harmonic series must diverge.

## Proof 37

This is another visual proof comparing the harmonic series to a divergent integral. It is similar to Proof 9 of [15].

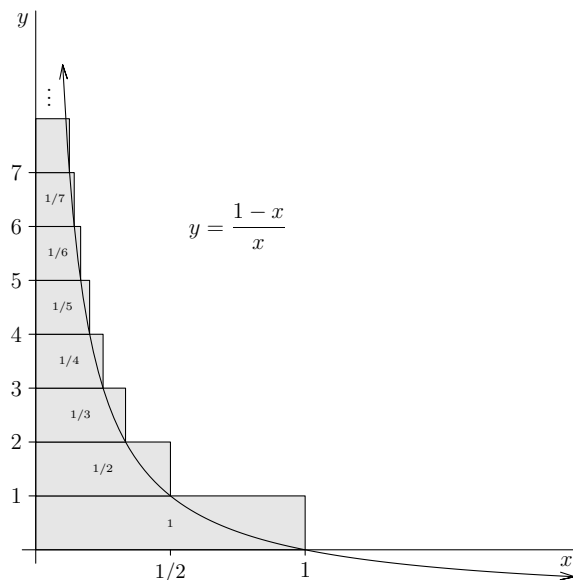

$$1 + \frac{1}{2} + \frac{1}{3} + \frac{1}{4} + \frac{1}{5} + \dots > \int_0^1 \frac{1-x}{x} dx = \infty$$

## Proof 38

Here is a matrix version of Johann Bernoulli's proof (Proof 13 of [15]). We start by defining the infinite matrices  $M$  (square) and  $h$ :

$$M = \begin{bmatrix} 0 & 2 & 0 & 0 & 0 & 0 & \dots \\ 0 & 0 & 3 & 0 & 0 & 0 & \dots \\ 0 & 0 & 0 & 4 & 0 & 0 & \dots \\ 0 & 0 & 0 & 0 & 5 & 0 & \dots \\ \vdots & \vdots & \vdots & \vdots & \vdots & \vdots & \ddots \end{bmatrix}, \quad h = \begin{bmatrix} 1 \\ 1/2 \\ 1/3 \\ 1/4 \\ \vdots \end{bmatrix}$$

Notice that  $h^T M h = \sum_{n=1}^{\infty} \frac{1}{n} = 1 + \frac{1}{2} + \frac{1}{3} + \frac{1}{4} + \dots$ . Therefore our goal is to show that  $h^T M h = \infty$ .

Let  $J_k$  be the infinite square matrix with ones along the superdiagonal starting at row  $k$  and with zeros

elsewhere. For example,

$$J_3 = \begin{bmatrix} 0 & 0 & 0 & 0 & 0 & 0 & \cdots \\ 0 & 0 & 0 & 0 & 0 & 0 & \cdots \\ 0 & 0 & 0 & 1 & 0 & 0 & \cdots \\ 0 & 0 & 0 & 0 & 1 & 0 & \cdots \\ 0 & 0 & 0 & 0 & 0 & 1 & \cdots \\ \vdots & \vdots & \vdots & \vdots & \vdots & \vdots & \ddots \end{bmatrix}.$$

It follows that  $M = J_1 + J_1 + J_2 + J_3 + J_4 + \cdots$  (in the sense that, for any  $n$ , the equality holds for the  $n \times n$  leading, principal submatrices).

By expanding  $h^T J_1 h$ , we find that

$$h^T J_1 h = \sum_{n=1}^{\infty} \frac{1}{n(n+1)} = 1.$$

From here it is easy to show (perhaps by induction) that

$$h^T J_k h = \frac{1}{k}.$$

Now suppose that the harmonic series converges with sum  $S$ . Then we have

$$\begin{aligned} S = h^T M h &= h^T (J_1 + J_1 + J_2 + J_3 + J_4 + \cdots) h \\ &= h^T J_1 h + h^T J_1 h + h^T J_2 h + h^T J_3 h + h^T J_4 h + \cdots \\ &= 1 + 1 + \frac{1}{2} + \frac{1}{3} + \frac{1}{4} + \cdots \\ &= 1 + S. \end{aligned}$$

The conclusion,  $S = 1 + S$ , is impossible unless  $S = \infty$ .

## Proof 39 (Cesàro summability)

It is not difficult to prove the following result (see for example [13, pages 128–129] or [16, page 4]), which was studied in detail by the Italian mathematician Ernesto Cesàro.

*Suppose that  $\sum_{k=1}^{\infty} a_k$  converges with sum  $S$  and let  $S_n = \sum_{k=1}^n a_k$ . Then the sequence of average partial sums,  $\{\frac{1}{n} \sum_{k=1}^n S_k\}_{n=1}^{\infty}$ , also converges to  $S$ .*

In order to use this result, let

$$H_n = 1 + \frac{1}{2} + \frac{1}{3} + \frac{1}{4} + \cdots + \frac{1}{n},$$

and notice that

$$\begin{aligned} \frac{1}{n} \sum_{k=1}^n H_k &= \frac{1}{n} \left( \frac{n}{1} + \frac{n-1}{2} + \frac{n-2}{3} + \cdots + \frac{1}{n} \right) \\ &= \frac{1}{n} \sum_{k=1}^n \frac{n-k+1}{k} = H_n - 1 + \frac{H_n}{n}. \end{aligned}$$

(A *Proof Without Words* for this last fact is given in [21].)

The divergence of the harmonic series now follows by contradiction. Assuming that the harmonic series converges with sum  $S$ , we have

$$S = \lim_{n \rightarrow \infty} \left( \frac{1}{n} \sum_{k=1}^n H_k \right) = \lim_{n \rightarrow \infty} \left( H_n - 1 + \frac{H_n}{n} \right) = S - 1 + 0.$$

A similar version of this proof was given by Aarao in [1]. In his article, Aarao went on to give a very nice description of how his proof was motivated by a probability problem. He explains, in several ways, why  $H_n$  is the expected number of draws required to empty an urn containing  $n$  balls if, on each draw, any choice of possible number of balls is equally likely.

## Proof 40

The following proof was given by Augustus De Morgan [8]. Similar to several of the previous proofs, it is included here for its historical significance. De Morgan claims to have been shown this proof many years prior to its publication by his young student J. J. Sylvester, who himself went on to become a famous mathematician. De Morgan's presentation is duplicated verbatim:

"It is well known that when  $a - b + c - d + \dots$  consists of terms diminishing without limit, the series is convergent, with a limit between  $a$  and  $a - b$ . Now

$$1 + \frac{1}{2} + \frac{1}{3} + \frac{1}{4} + \dots \quad \text{is} \quad 1 - \frac{1}{2} + \frac{1}{3} - \frac{1}{4} + \dots \\ + 1 \qquad \qquad \qquad + \frac{1}{2} + \dots$$

And if it be  $S$ , we have  $S = a + S$ , where  $a$  is finite. Hence  $S$  is infinite."

## Proof 41

This proof was given by Cusumano [7]. Suppose  $m$  is an integer greater than 1.

$$\begin{aligned} \sum_{n=1}^{\infty} \frac{1}{n} &= \left( \frac{1}{1} + \dots + \frac{1}{m} \right) + \left( \frac{1}{m+1} + \dots + \frac{1}{m^2} \right) \\ &\quad + \left( \frac{1}{m^2+1} + \dots + \frac{1}{m^3} \right) + \left( \frac{1}{m^3+1} + \dots + \frac{1}{m^4} \right) + \dots \\ &> \frac{m}{m} + \frac{m^2 - m}{m^2} + \frac{m^3 - m^2}{m^3} + \frac{m^4 - m^3}{m^4} + \dots \\ &= 1 + \frac{m(m-1)}{mm} + \frac{m^2(m-1)}{m^2m} + \frac{m^3(m-1)}{m^3m} + \dots \\ &= 1 + \frac{m-1}{m} + \frac{m-1}{m} + \frac{m-1}{m} + \dots \\ &= \infty \end{aligned}$$

Notice that if the first term on the right is rewritten,

$$\left(\frac{1}{1} + \cdots + \frac{1}{m}\right) = 1 + \left(\frac{1}{2} + \cdots + \frac{1}{m}\right),$$

Cusumano's proof becomes precisely the generalization of Oresme's classical proof that was described after Proof 1 of [15].

## Proof 42 (Euler's constant)

There are a variety of proofs of divergence of the harmonic series that in some way make use of the Euler-Mascheroni constant. This constant is often defined by the following limit:

$$\gamma = \lim_{n \rightarrow \infty} \left( \sum_{k=1}^n \frac{1}{k} - \ln(n) \right) \approx 0.5772156649.$$

Once this limit has been established (see for example [18, page 623, exercise 75]), it is clear that the partial sums,  $H_n = \sum_{k=1}^n \frac{1}{k}$ , are unbounded.

Here is a different proof involving  $\gamma$ . Let  $n$  be a fixed positive integer. For  $k = 1, 2, 3, \dots$ , let

$$S_k = \frac{1}{k} - \sum_{j=1}^n \frac{1}{kn + j}.$$

For example,

$$S_1 = 1 - \frac{1}{n+1} - \frac{1}{n+2} - \cdots - \frac{1}{2n},$$

$$S_2 = \frac{1}{2} - \frac{1}{2n+1} - \frac{1}{2n+2} - \cdots - \frac{1}{3n},$$

and

$$S_{n-1} = \frac{1}{n-1} - \frac{1}{(n-1)n+1} - \frac{1}{(n-1)n+2} - \cdots - \frac{1}{n^2}.$$

Since

$$\frac{n}{kn+n} < \sum_{j=1}^n \frac{1}{kn+j} < \frac{n}{kn+1},$$

we have

$$0 < \frac{1}{k} - \frac{n}{kn+1} < S_k < \frac{1}{k} - \frac{n}{kn+n} = \frac{1}{k} - \frac{1}{k+1}.$$

It follows that the sequence  $\{\sum_{k=1}^m S_k\}_{m=1}^{\infty}$  is increasing, bounded above by  $\sum_{k=1}^{\infty} \left(\frac{1}{k} - \frac{1}{k+1}\right) = 1$ , and therefore convergent to a positive number no greater than 1. The limit is in fact  $\gamma$  (see [20]).

Now notice that

$$S_1 + S_2 + \cdots + S_{n-1} + \frac{1}{n} = 2H_n - H_{n^2}.$$

Assuming that the harmonic series converges to  $H$  and taking the limit as  $n \rightarrow \infty$ , we have

$$\gamma = 2H - H = H,$$

an obvious contradiction.



## Proof 43

This is the essence of a proof recently presented by Sinha [26]. The proof is similar to a number of those given above.

Let

$$H_n = 1 + \frac{1}{2} + \frac{1}{3} + \frac{1}{4} + \cdots + \frac{1}{n},$$

and notice that

$$H_{k+m} = H_k + \frac{1}{k+1} + \frac{1}{k+2} + \cdots + \frac{1}{k+m} > H_k + \frac{m}{k+m}.$$

For each positive integer  $k$ ,  $m/(k+m) \rightarrow 1$  as  $m \rightarrow \infty$ . Now let  $\epsilon$  be any fixed real number such that  $0 < \epsilon < 1$ . It follows that for any  $k$ , there exists an  $m$  so that

$$H_{k+m} > H_k + \epsilon.$$

Thus the sequence  $\{H_n\}_{n=1}^{\infty}$  cannot have an upper bound, and the harmonic series diverges.

## Proof 44

This proof, presented by Rooin [25], gives a very general result concerning groupings of the terms of the harmonic series.

Let  $\{i_k\}_{k=1}^{\infty}$  be any nondecreasing sequence of positive integers. Let  $I_0 = 0$  and, for  $k = 1, 2, 3, \dots$ ,  $I_k = i_1 + i_2 + \cdots + i_k$ . Then

$$\begin{aligned} \sum_{n=1}^{\infty} \frac{1}{n} &= \sum_{j=1}^{\infty} \left( \sum_{k=1}^{i_j} \frac{1}{I_{j-1} + k} \right) > \sum_{j=1}^{\infty} \left( \sum_{k=1}^{i_j} \frac{1}{I_{j-1} + i_j} \right) \\ &= \sum_{j=1}^{\infty} \frac{i_j}{I_j} \geq \sum_{j=1}^{\infty} \frac{i_j}{j i_j} = \sum_{j=1}^{\infty} \frac{1}{j}, \end{aligned}$$

which is a contradiction.

## Proof 45

This is not a proof for first-year calculus students, but it is a classic. It is included just for good measure.

Suppose the harmonic series converges with sum  $S$ . For each positive integer  $n$ , let

$$g_n(x) = \begin{cases} \frac{1}{n}, & n-1 \leq x \leq n \\ 0, & \text{otherwise} \end{cases}.$$

The series  $\sum_{k=1}^{\infty} g_k(x)$  converges uniformly (by the Weierstrass M-test) to the function  $g(x)$ , which is integrable with

$$\int_0^{\infty} g(x) dx = S.$$

Now let

$$f_n(x) = \begin{cases} \frac{1}{n}, & 0 \leq x \leq n \\ 0, & \text{otherwise} \end{cases}.$$

Notice that  $f_n(x) \leq g(x)$  for all  $n$  and  $x$ , so that the sequence of functions  $\{f_n\}_{n=1}^{\infty}$  is dominated by  $g$ . Also notice that  $\lim_{n \rightarrow \infty} f_n(x) = 0$  for each  $x$  and that

$$\int_0^{\infty} f_n(x) dx = 1$$

for each  $n$ . Thus by the Dominated Convergence Theorem,

$$0 = \int_0^{\infty} \lim_{n \rightarrow \infty} f_n(x) dx = \lim_{n \rightarrow \infty} \int_0^{\infty} f_n(x) dx = 1.$$

This contradiction concludes the proof.

## Proof 46 (An HM-AM proof)

Ángel Plaza presented this proof in [24]. It makes use of a simple, special case of the harmonic mean-arithmetic mean (HM-AM) inequality.

First, based on the HM-AM inequality,

$$\frac{\frac{1}{a} + \frac{1}{b}}{2} \geq \frac{2}{a+b} \quad \text{or} \quad \frac{1}{a} + \frac{1}{b} \geq \frac{4}{a+b},$$

for positive numbers  $a$  and  $b$ . Now suppose the harmonic series converges with sum  $S$ . Then

$$\begin{aligned} S &= \sum_{n=1}^{\infty} \frac{1}{n} = \sum_{n=0}^{\infty} \left( \frac{1}{2n+1} + \frac{1}{2n+2} \right) \\ &\geq \sum_{n=0}^{\infty} \frac{4}{4n+3} \quad (\text{using the result above}) \\ &> \sum_{n=0}^{\infty} \frac{4}{4n+4} = \sum_{n=0}^{\infty} \frac{1}{n+1} = S. \end{aligned}$$

The contradiction  $S > S$  concludes the proof.

This proof is quite similar to Proof 6 of [15] (which does not require the HM-AM inequality). An entire family of divergence proofs can be derived by using the HM-AM inequality. See Proof 3 of [15] for a brief discussion.

## Proof 47 (An AM-GM proof)

This proof was also presented by Plaza [23]. It makes use of a special case of the arithmetic mean-geometric mean (AM-GM) inequality:

$$\frac{\frac{1}{a} + \frac{1}{b}}{2} \geq \frac{1}{\sqrt{ab}} \quad \text{or} \quad \frac{1}{a} + \frac{1}{b} \geq \frac{2}{\sqrt{ab}},$$

for positive numbers  $a$  and  $b$ .

Suppose the harmonic series converges with sum  $S$ . Then

$$\begin{aligned}
 S &= \sum_{n=1}^{\infty} \frac{1}{n} = \sum_{n=0}^{\infty} \left( \frac{1}{2n+1} + \frac{1}{2n+2} \right) \\
 &\geq \sum_{n=0}^{\infty} \frac{2}{\sqrt{(2n+1)(2n+2)}} \quad (\text{using the result above}) \\
 &> \sum_{n=0}^{\infty} \frac{2}{\sqrt{(2n+2)(2n+2)}} = \sum_{n=0}^{\infty} \frac{2}{2n+2} = \sum_{n=0}^{\infty} \frac{1}{n+1} = S.
 \end{aligned}$$

The contradiction  $S > S$  concludes the proof.

## Proof 48 (Using the Riemann Hypothesis)

This “proof” requires some deep and profound results—it is included in the collection just for fun.

In [17], Lagarias connected the Riemann hypothesis to an elementary problem involving the harmonic numbers. He proved the following:

*Let  $\sigma(n)$  be the sum of all positive divisors of the natural number  $n$ . The Riemann hypothesis is equivalent to the assertion that*

$$\sigma(n) \leq H_n + e^{H_n} \ln(H_n)$$

*for every natural number  $n$ .*

Now if we make the reasonable assumption that the Riemann hypothesis is true, then Lagarias’s result immediately implies that  $H_n$  is unbounded.

## Some additional proofs

Here are a couple of proofs involving probability theory. Because they are too advanced for the typical calculus student, they are not duplicated here.

- $\sum \frac{1}{n} = \infty$ : *A Micro-Lesson on Probability and Symmetry* by Omer Adleman, Amer. Math. Monthly, November 2007, pages 809–810
- *A Proof of Divergence of the Harmonic Series Using Probability Theory* by Arnab Kumar Laha, International Journal of Mathematical Education in Science and Technology, June 2006, pages 502–503

Here are some proofs that are nearly identical to proofs presented in [15], but were independently discovered and presented.

- *The harmonic series again* by M.R. Chowdhury, The Mathematical Gazette, Volume 59, October 1975, page 186. This proof is identical to Proof 6 of [15], in which credit was given to Leonard Gillman via Honsberger. Chowdhury’s proof predates Honsberger’s credit to Gilman.

- A short(er) proof of the divergence of the harmonic series by Leo Goldmakher, available at <https://web.williams.edu/Mathematics/lg5/harmonic.pdf>. This is another rendition of the Gillman/Honsberger/Chowdhury proof.

## References

- [1] J. AARAO, *A harmonic note*, Math Horizons, 14 (2006), p. 14.
- [2] R. L. BAKER, *An exceedingly short proof that the harmonic series diverges*, Missouri Journal of Mathematical Sciences, 27 (2015), pp. 95–96.
- [3] E. R. BOBO, *A sequence related to the harmonic series*, Coll. Math. J., 26 (1995), pp. 308–310.
- [4] D. M. BRADLEY, *A note on the divergence of the harmonic series*, Amer. Math. Monthly, 107 (2000), p. 651.
- [5] H. CHEN AND C. KENNEDY, *Harmonic series meets Fibonacci sequence*, Coll. Math. J., 43 (2012), pp. 237–243.
- [6] D. T. CLANCY AND S. J. KIFOWIT, *A closer look at Bobo’s sequence*, Coll. Math. J., 45 (2014), pp. 199–206.
- [7] A. CUSUMANO, *Generalization of Oresme’s standard method of showing the divergence of the harmonic series*, Amer. Math. Monthly, 119 (2012), p. 210.
- [8] A. DE MORGAN, *On the summation of divergent series*, The Assurance Magazine, and the Journal of the Institute of Actuaries, 12 (1865), pp. 245–252.
- [9] W. DUNHAM, *Euler: The Master of Us All*, The Mathematical Association of America, 1999.
- [10] P. ERDŐS, *Über die Reihe  $\sum \frac{1}{p}$* , Mathematica, Zutphen B 7 (1938), pp. 1–2.
- [11] A. FEARNEHOUGH, *Another method for showing the divergence of the harmonic series*, The Mathematical Gazette, 75 (1991), p. 198.
- [12] J. HAVIL, *Gamma: Exploring Euler’s Constant*, Princeton University Press, 2003.
- [13] I. I. HIRSCHMAN JR., *Infinite Series*, Holt, Rinehart and Winston, 1962.
- [14] S. J. KIFOWIT AND T. A. STAMPS, *Serious About the Harmonic Series II*. Presented at the 31st Annual Conference of the Illinois Mathematics Association of Community Colleges, Monticello, IL, March 31, 2006. Available at <http://stevekifowit.com/pubs/all.pdf>.
- [15] ———, *The harmonic series diverges again and again*, The AMATYC Review, 27 (2006), pp. 31–43.
- [16] T. W. KÖRNER, *Fourier Analysis*, Cambridge University Press, 1988.

- [17] J. C. LAGARIAS, *An elementary problem equivalent to the Riemann hypothesis*, Amer. Math. Monthly, 109 (2002), pp. 534–543.
- [18] R. LARSON, R. P. HOSTETLER, AND B. H. EDWARDS, *Calculus*, Houghton Mifflin Company, 8th ed., 2006.
- [19] N. LORD, *Maths bite: seeing the divergence of the harmonic series*, The Mathematical Gazette, 87 (2003), pp. 125–126.
- [20] J. J. MAČYS, *A new problem*, Amer. Math. Monthly, 119 (2012), p. 82.
- [21] R. B. NELSON, *Proofs Without Words II: More Exercises in Visual Thinking*, The Mathematical Association of America, 2000.
- [22] J. C. OWINGS JR., *Another proof of the Egyptian fraction theorem*, Amer. Math. Monthly, 75 (1968), pp. 777–778.
- [23] A. PLAZA, *The generalized harmonic series diverges by the AM-GM inequality*, Mathematics Magazine, 91 (2018), p. 217.
- [24] ———, *The harmonic series diverges*, Amer. Math. Monthly, 125 (2018), p. 222.
- [25] J. ROOIN, *Grouping of terms and divergence of the harmonic series*, The Mathematical Gazette, 85 (2001), pp. 512–513.
- [26] P. SINHA, *An easy proof of the divergence of the harmonic series sum*, Amer. Math. Monthly, 120 (2013), p. 354.
- [27] J. STEWART, *Calculus*, Brooks/Cole, 5th ed., 2003.
- [28] A. J. B. WARD, *Divergence of the harmonic series*, The Mathematical Gazette, (C) (1970), p. 277.